

Kessil

Spectral Controller X

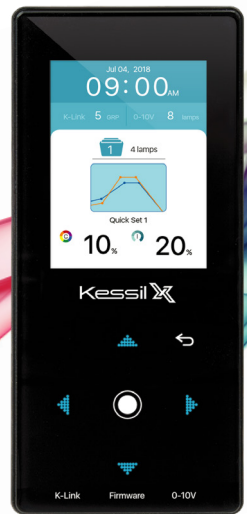

Quick Start Guide

INSIDE THE BOX

- Spectral Controller X

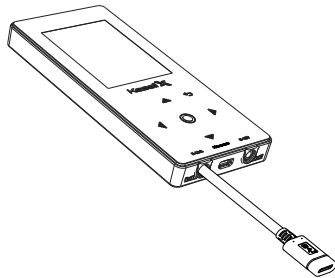

- Magnetic Back Plate

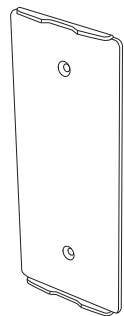

- Micro USB Cable (for firmware update)

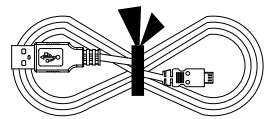

- K-Link Cable (10')

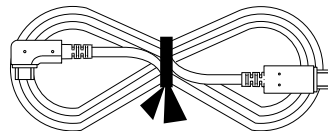

- Screws x 2
- Nylon anchor x 2

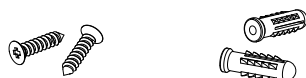

NAVIGATION

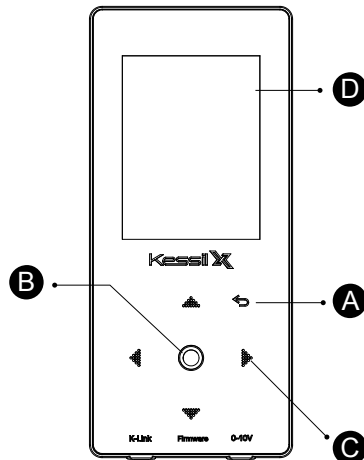

- A Return
- B Enter
- C Direction Pad
- D Display Screen

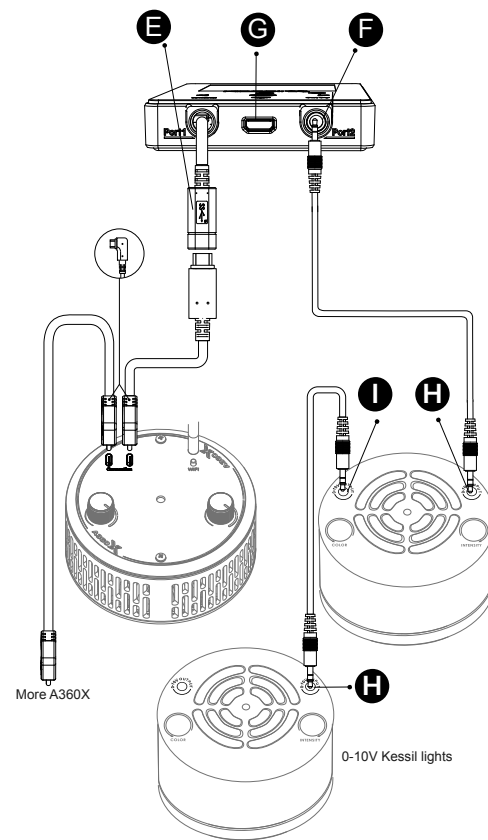

GETTING STARTED

Step 1 Power

- Plug the K-Link Cable (10') to the K-Link (female).
- Plug the other end to the A360X K-Link Port.
- Plug the A360X to the power supply and plug the AC cable of the power supply to a wall outlet.

Alternative

- Plug the Micro USB Cable to the Micro-USB port and to a 5V/1A USB power adapter. (USB power adapter not included)

* The Spectral Controller X can be powered off through A360X if the controller is not connected to a 5V/1A USB power adapter.

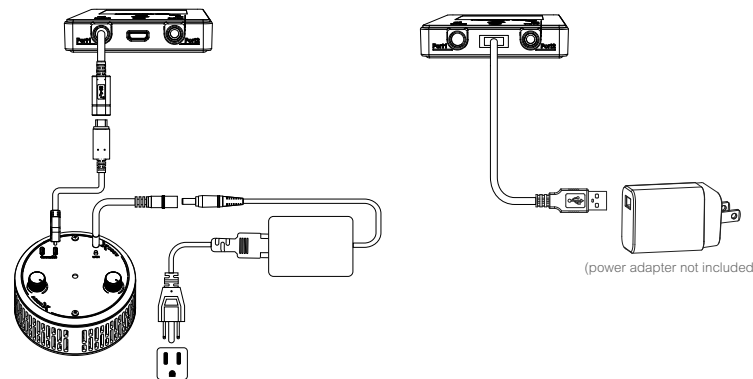

f kessil.led

YouTube kessiltube

@kessilled

kessil.com

Kessil Lighting

A DiCon Brand
 1689 Regatta Blvd,
 Richmond, CA 94804
 (510) 620-5250

Step 2 Set Up

- Use the Direction Pad (C) to navigate to the **Settings** tab.
- Press **○** to access the settings.
- Press **←** to return to tab options.

Demo Setting

- Demo mode: When Demo Mode is turned on, any adjustments will not be saved. After the set minutes of inactivity, light will automatically revert back to the settings/programs prior to Demo Mode.

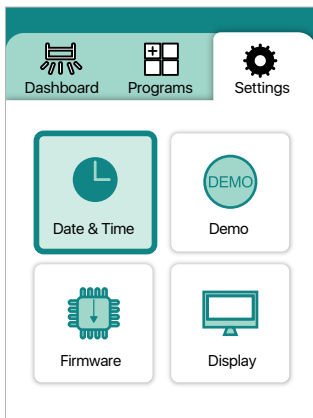

Step 3 Choose the Program

- The Status Page will cycle through the status of each group every 2 seconds.
- Press **○** to enter tab options. Press **○** one more time to enter Dashboard.
- In the Dashboard, press **⏪** to select group, press **⏩** to select program quickly and press **○** to set the Group and Manual Color details.

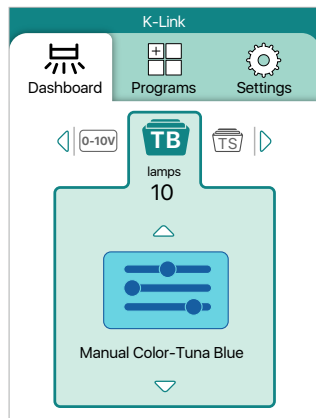
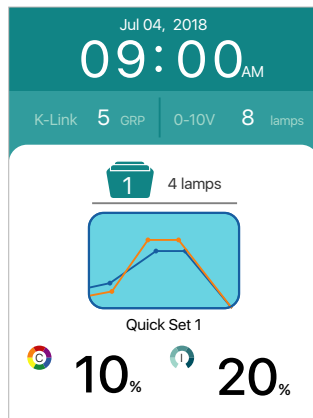

Step 4 Set the Group

- Navigate to the **Group** tab via manual mode, press **⏪** until **↔** is selected and press **○** to enter group arrangement mode.
- Press **⏪** **⏩** to select lamps and navigate to the desired interacting group (bottom part).
- Press **○** to move lamps from active group (top part) to interacting group (bottom part) or vice versa.

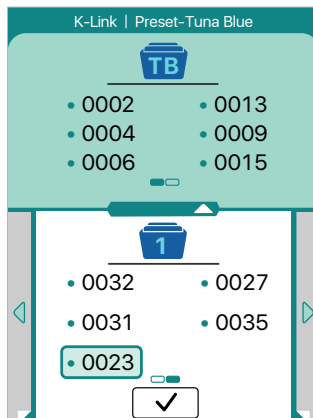

Step 5 Program

- Use the Direction Pad (C) to navigate to the Programs tab.
- Press **○** to access the programs settings
- Press **⏪** **⏩** to navigate between preset programs or new program and press **○** to enter.
- Press **⏪** **⏩** to choose time point and press **○** to enter for detail settings.
- Press **⏪** **⏩** to navigate between functional settings, press **⏪** to adjust value.

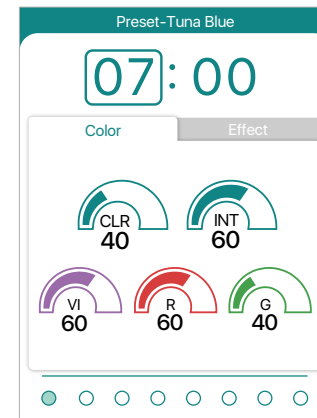

Step 6 Mounting

- Use the screws provided to mount the magnetic back plate to a wooden surface.
- If mounting to a dry wall, pre-drill two 1/4" (6.5mm) holes and insert nylon anchors before screwing the plate in.

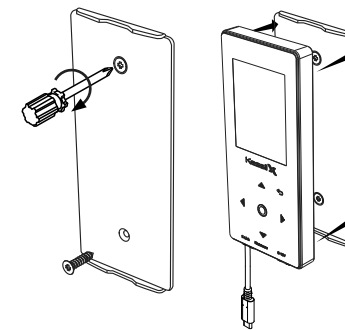

Job well done !

SAFETY INSTRUCTIONS

1. DO NOT use a power adapter outside the specifications. This is a fire hazard and may lead to unit failure.
2. DO NOT use outdoors. This unit is intended for indoor use only.
3. DO NOT expose unit to an extremely humid environment or submerge unit in water.
4. DO NOT mount over open water.
5. ENSURE that the back plate is correctly mounted to a steady surface. Incorrect mounting can result in detachment of the plate and controller.

DC input

Power consumption	1W maximum
Input Voltage	5VDC +-5%

* Power adapter not included

For further assistance, contact Kessil customer service at (510) 620-5250.